

Instructions for installing roof boards on houses with 4 walls. (Pyramid hip roof)

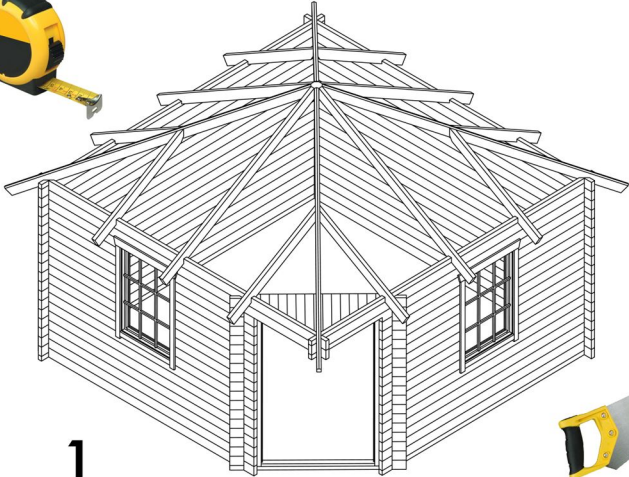

1
measure

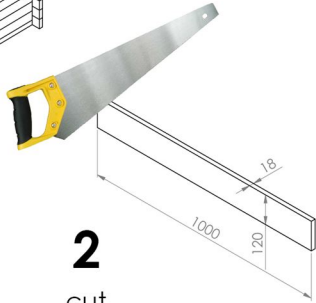

2
cut



3
install

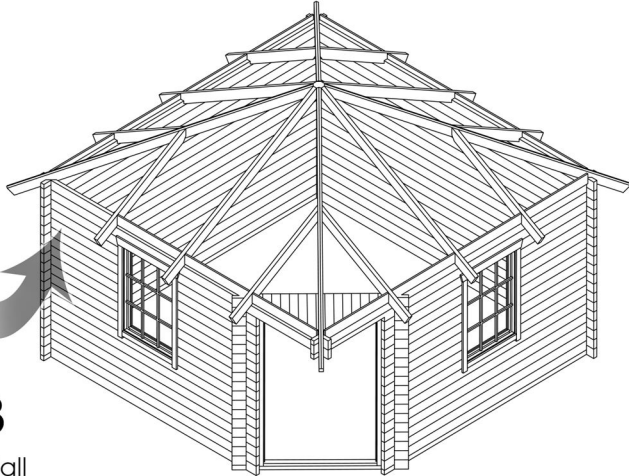

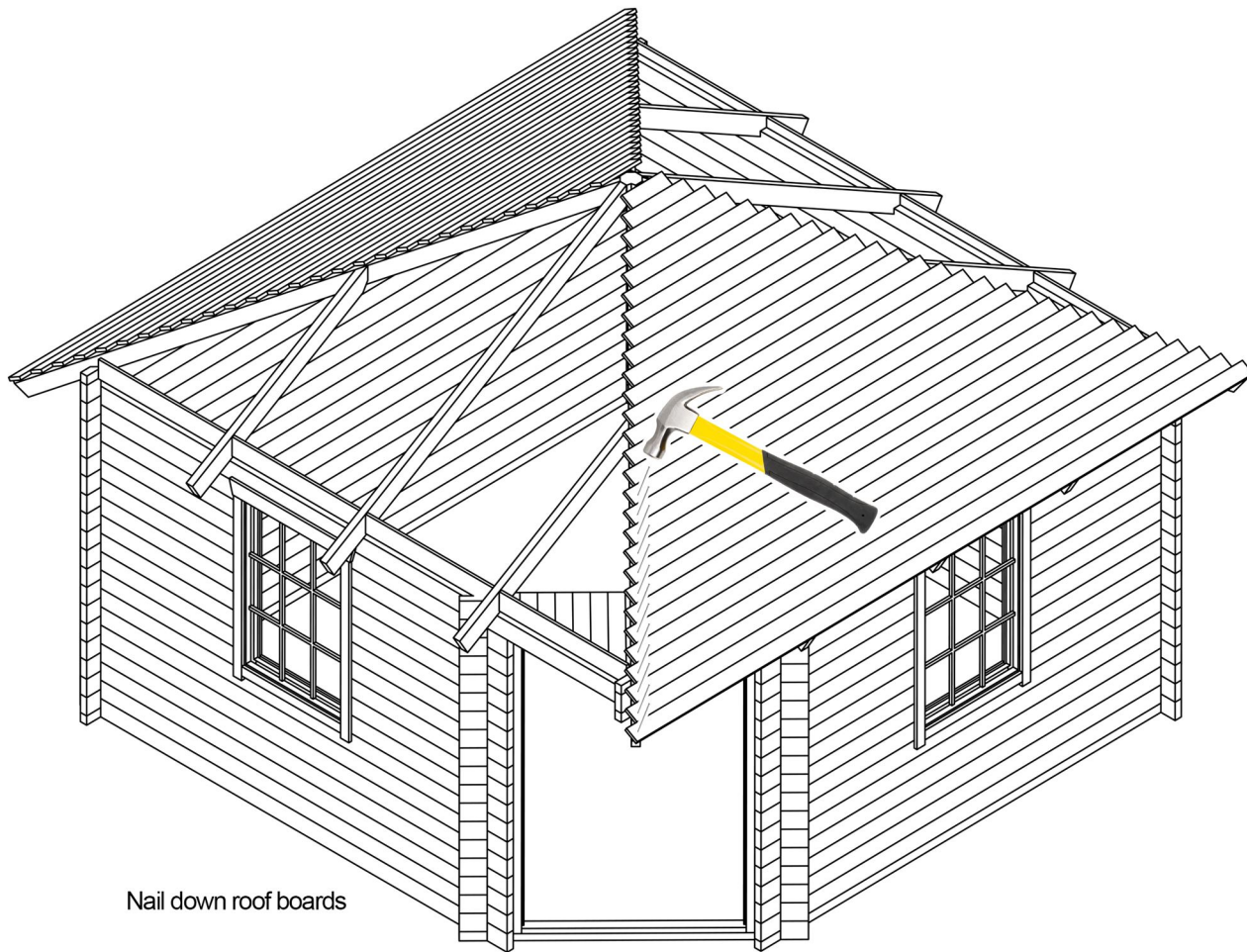

Nail down roof boards

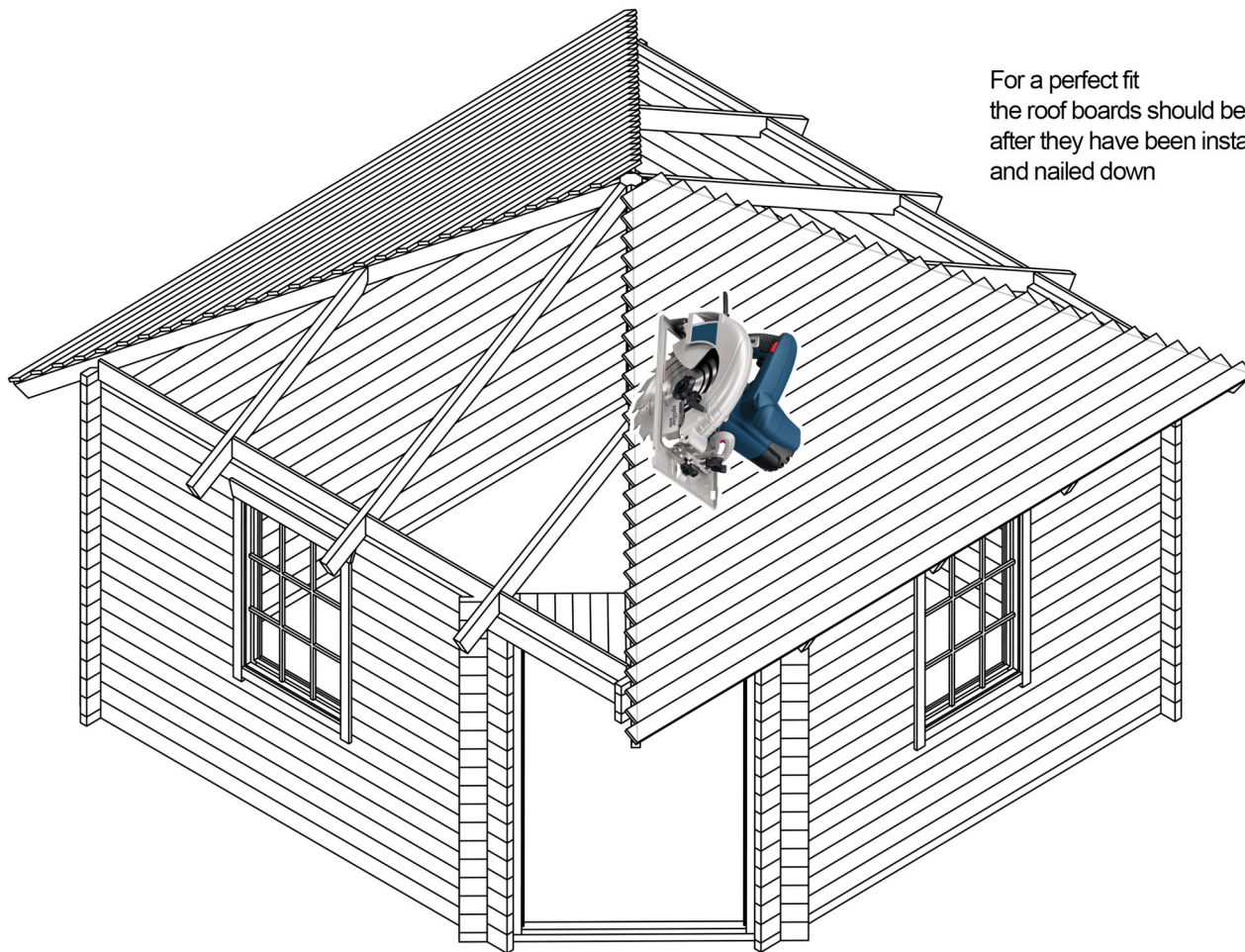

For a perfect fit
the roof boards should be sawn
after they have been installed
and nailed down

Measure triangle dimensions



Mark dimensions on roof boards



Saw roof boards

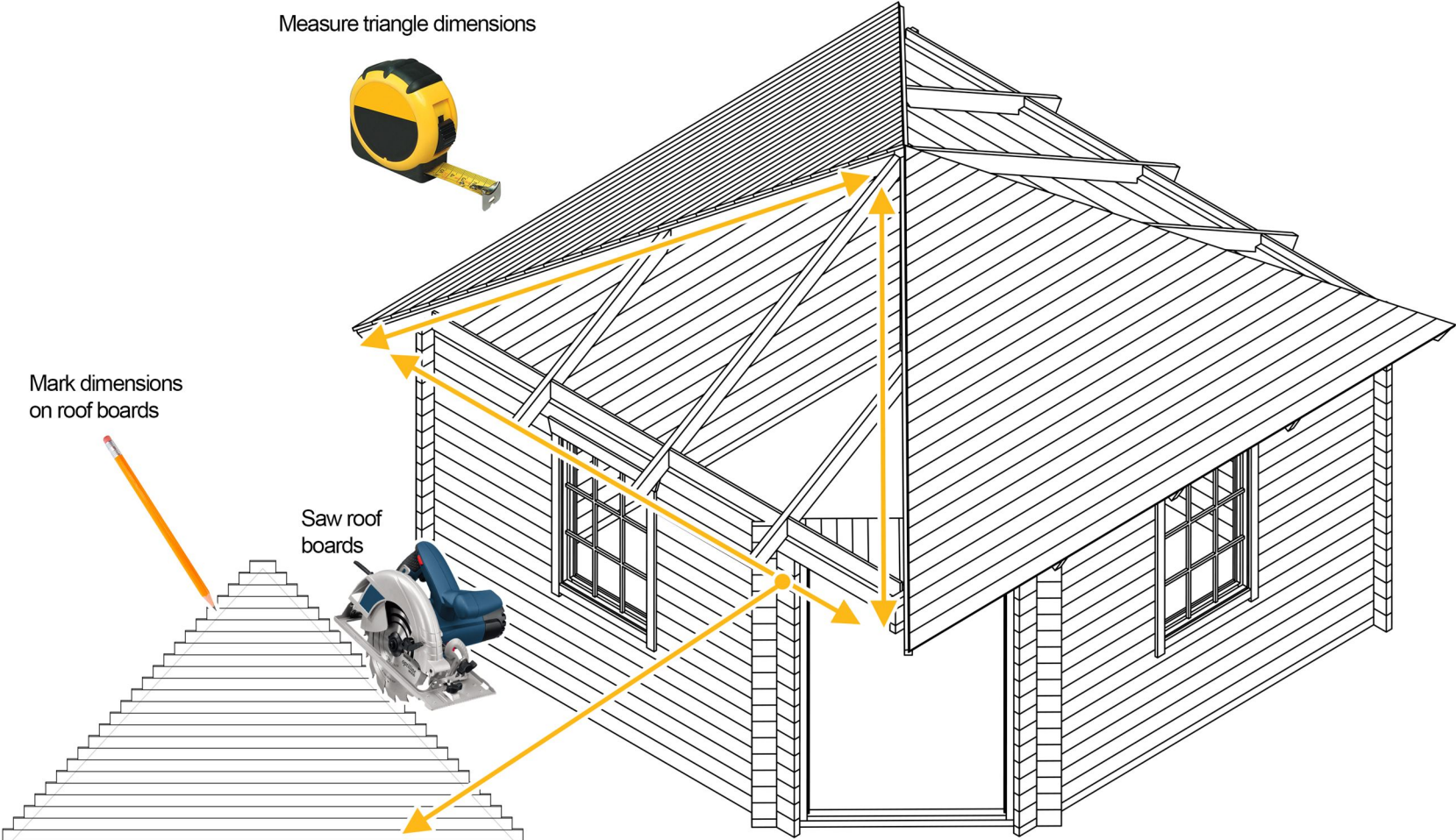
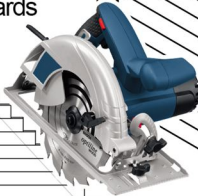

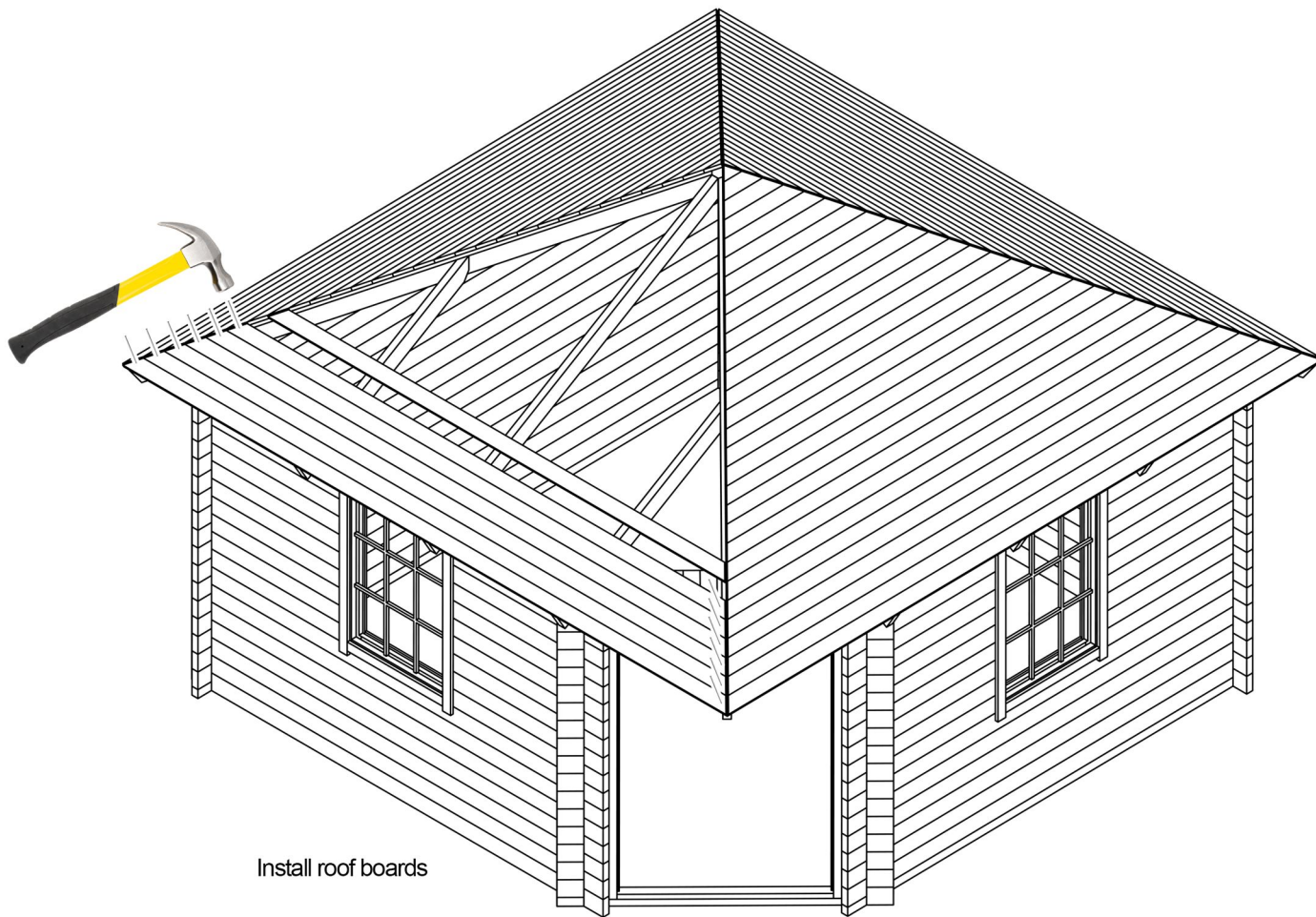

Install roof boards

Install eave boards



4x40

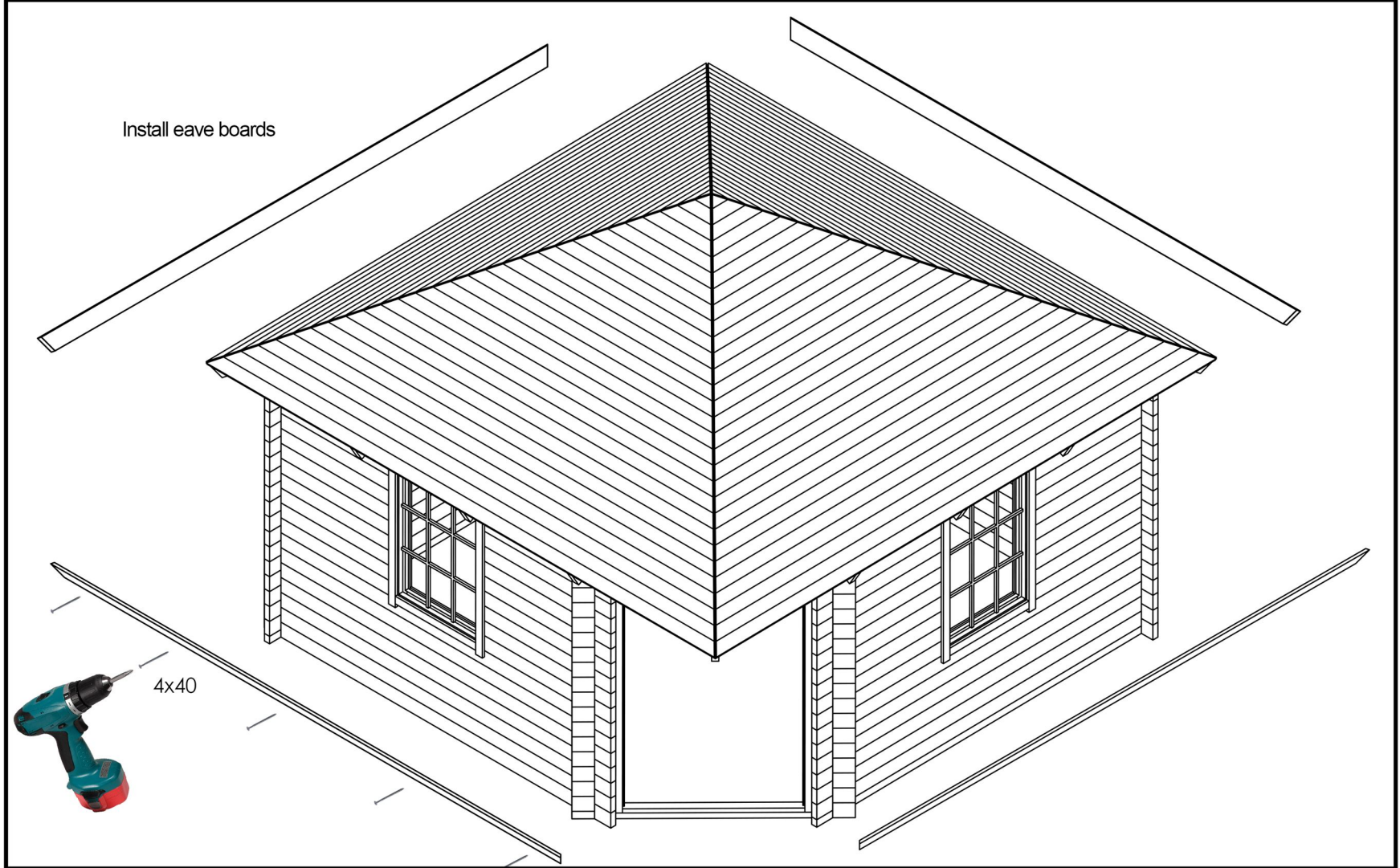

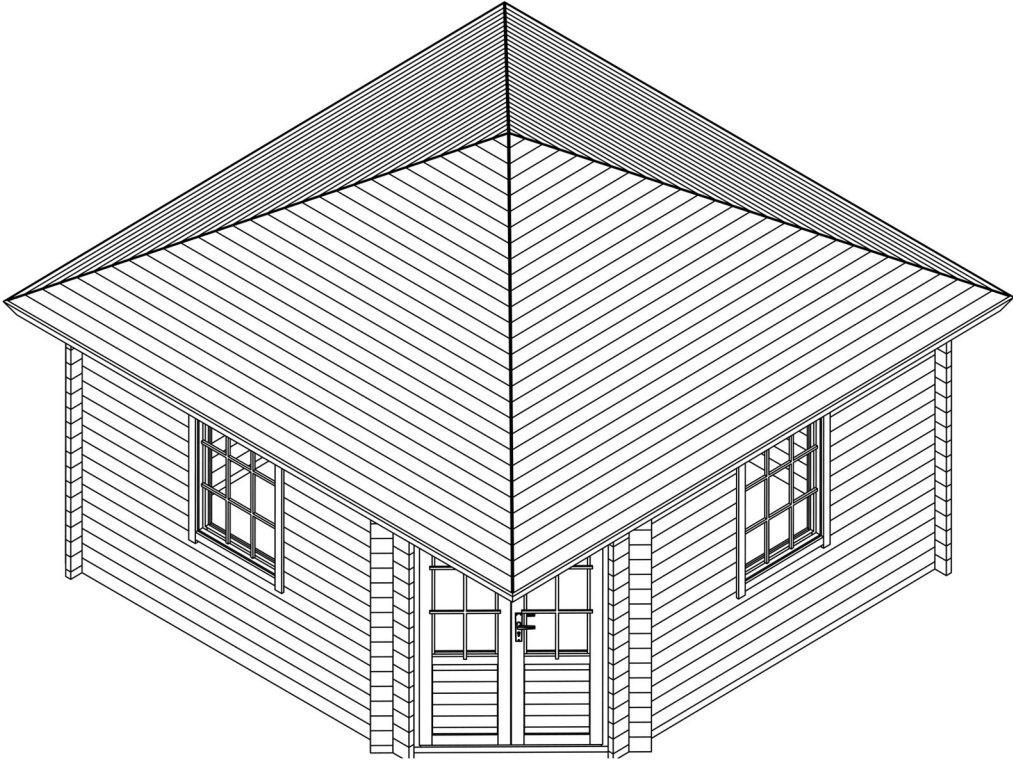

Section view

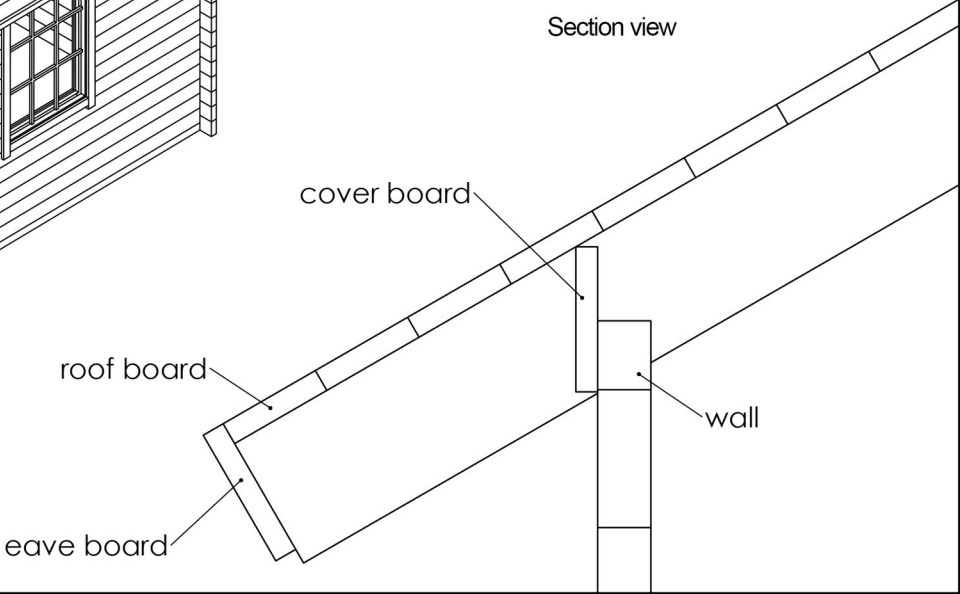

Instructions for installing roof boards on pavillion type garden houses with 6 or 8 walls. (Gazebo hip roof)

Nail down roof boards

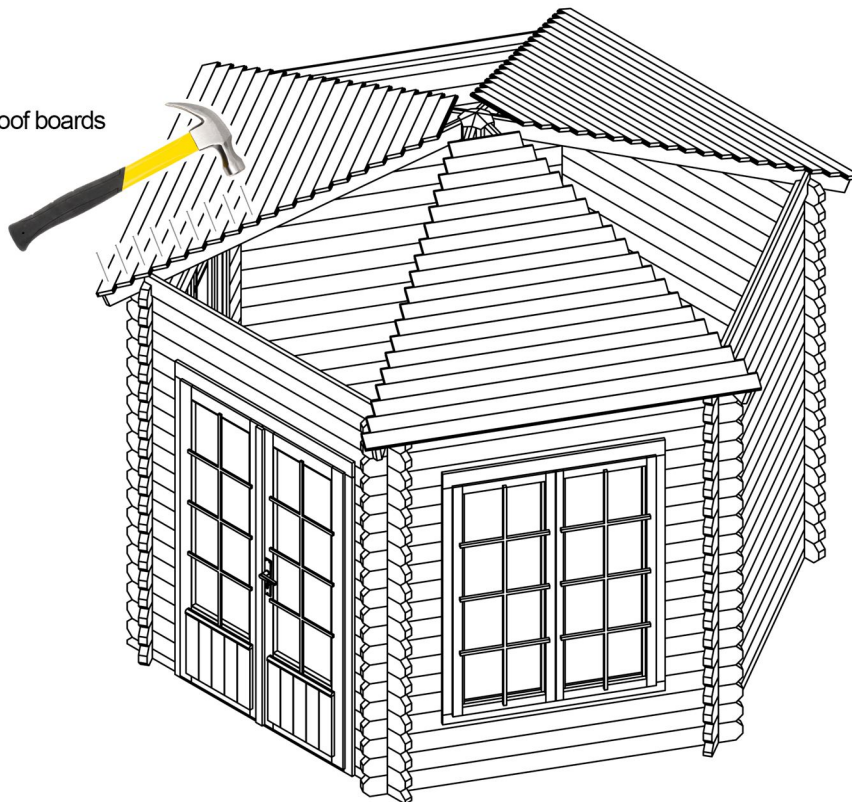

Saw roof boards

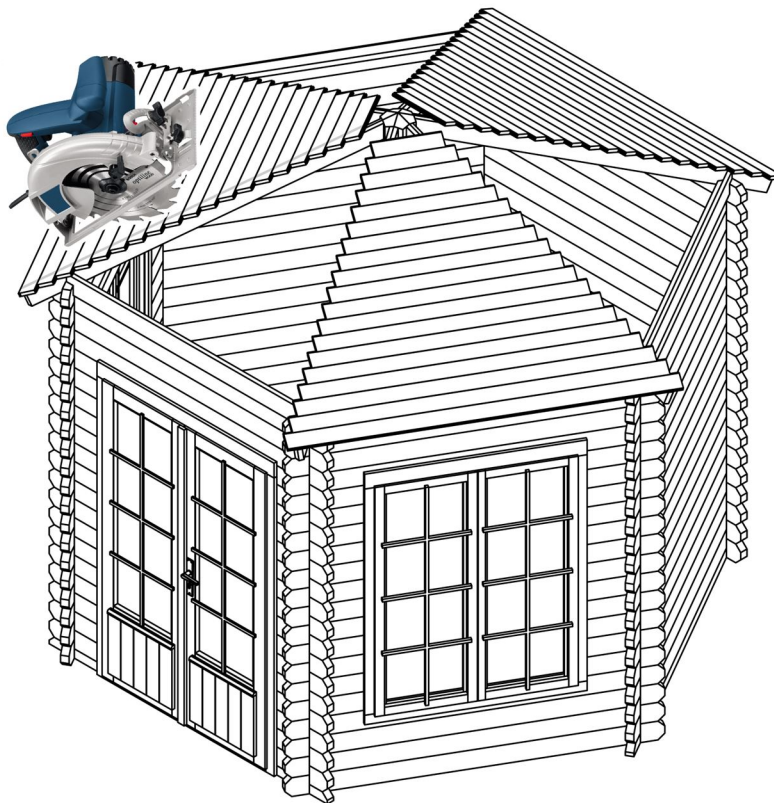

Measure triangle dimensions

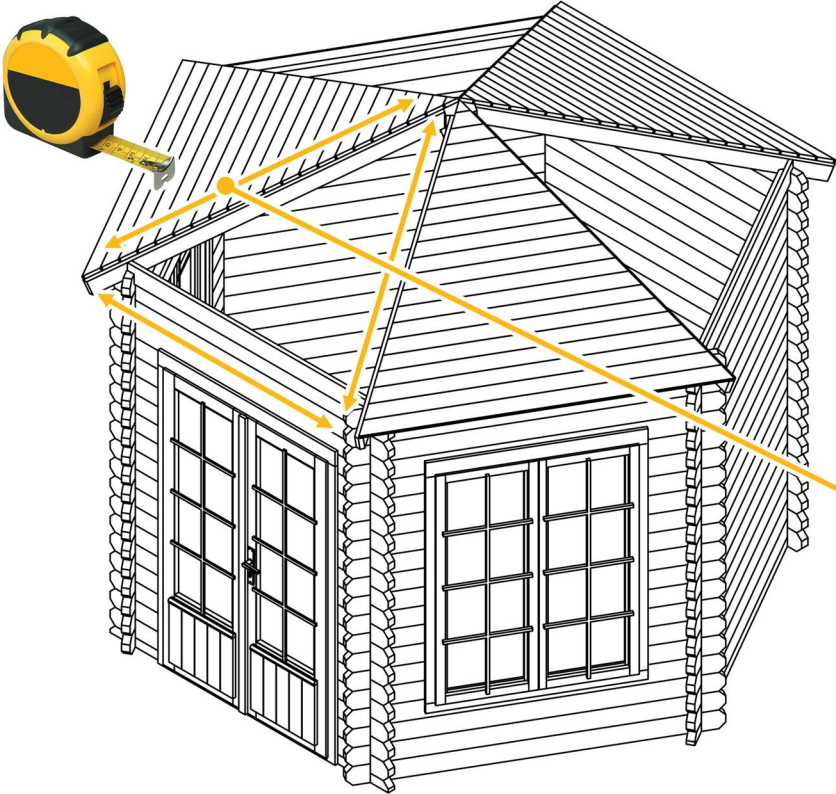

Mark dimensions on roof boards

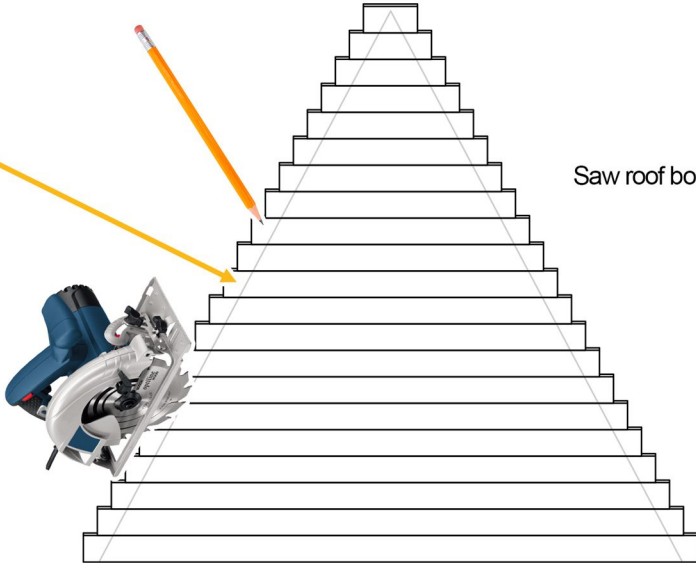

Saw roof boards

Install roof boards

